

Part # **PLCC20**
 Leads **20** Pitch **1.27mm (50mils)**
 Body Size **8.9mm (.35" SQ)**

Dwg PLCC20.pdf

TopLineTM
 Tel 1-714-898-3830
 info@topline.to

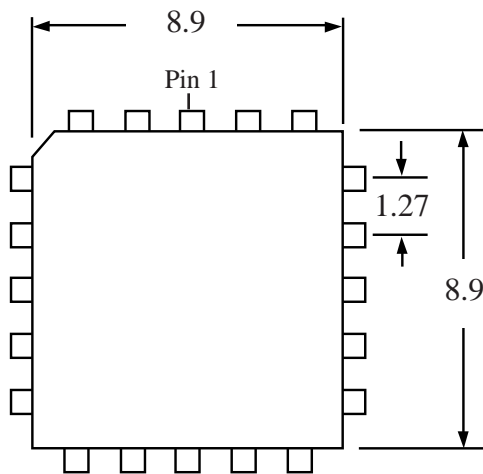

Top View

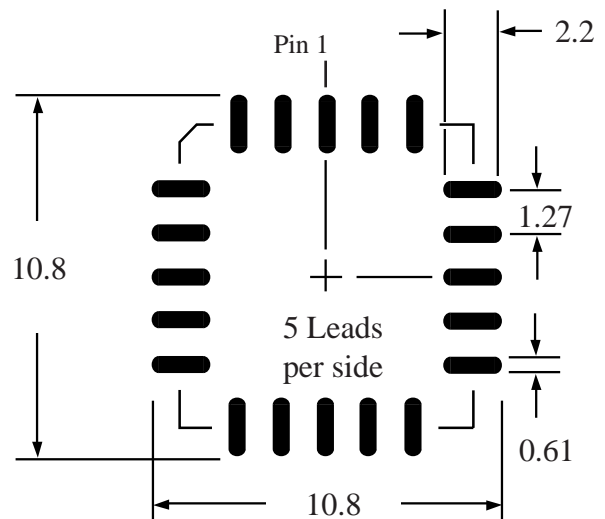

PC Board

Dimensions = mm

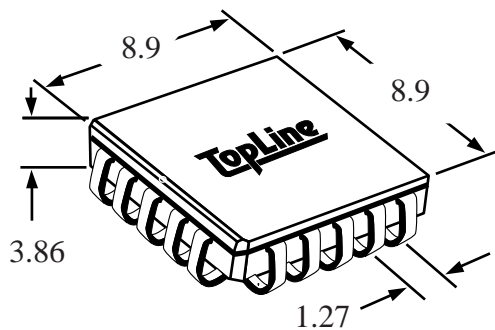

Quick View

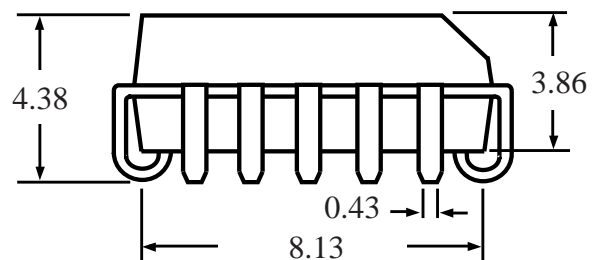

Side View Detail